

QRC series
S7-L, S7-P, S7-PO
Socket for printed circuit for miniature relays C7

Type	S7-L 2-pole, fange panel mountable
	S7-P 2-pole, printed circuit
	S7-PO 2-pole, printed circuit with fange

Rated current **10 A**

Specifications	
Rated load	10 A/250 V
Dielectric strength adjacent pin	2.5 kV rms 1 min
Connection label	1...8; DIN/EN
Integrated retaining clip/plastic	for relay series C7
Ambient temperature operation/storage	-40 (no ice)...60 °C / -40 ... 80 °C



Printed circuit lay-out [mm]

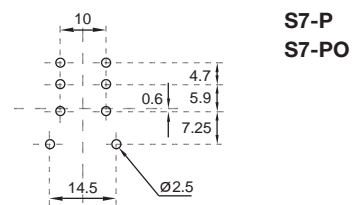

Dimensions [mm]

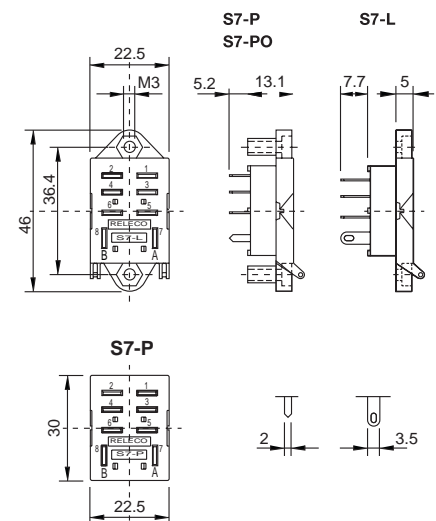

Technical approvals, conformities



EN 60947-1, EN 61810-5



Kühn Controls AG

Notes:

You want more information about this product, please call us: tel: +49 (0)7082-940000 or send us a fax: +49 (0)7082-940001, or email: sales@kuehn-controls.de or visit our Website: www.kuehn-controls.de